

OPERATING INSTRUCTIONS

ADE

Burger forming machine



Bully1000-230

Bully1000-240618-Rev003-UM-en



CONTENTS

1.	FOREWORD	2
1.1	Introduction.....	2
1.2	Intended use.....	2
1.3	Residual risks	3
2.	MACHINE OVERVIEW	3
3.	INSTALLATION AND START-UP	5
3.1	Scope of Supply	5
3.2	Unpacking	5
3.3	Setting up the machine	6
3.4	Installing the conveyor belt	6
3.5	Installing the scraper.....	7
3.6	Fitting the squeegee	7
3.7	Connecting to the power supply	7
3.8	Electrical safety devices.....	8
3.9	Safety precautions	8
3.10	Acceptance testing	9
4.	USING THE BURGER FORMER.....	10
4.1	Operating functions.....	10
4.2	Switching on	10
4.3	Securing the machine against accidental switch-on	10
4.4	Switching off	10
4.5	Feeding in food and cutting.....	10
5.	INSERTING RELEASE PAPER.....	11
6.	ADJUSTING PRODUCT THICKNESS AND WEIGHT	12
7.	CLEANING AND CARE	13
8.	TRAINING	16
9.	DISPOSAL	16
10.	WARRANTY	17
11.	TECHNICAL DATA.....	18
12.	DECLARATION OF CONFORMITY	19
13.	DIAGRAMS	20
14.	SPARE PARTS/ACCESSORIES	21

1. FOREWORD



This symbol means: "Observe operating instructions." Read these operating instructions carefully and observe the information contained therein. Keep these operating instructions handy for future reference.

This manual has been written to comply with the Machinery Directive as amended.

With it, the manufacturer intends to furnish the customer with clear and concise instructions for the use and maintenance of the machine, as well as information regarding the safety devices with which it is fitted to assure maximum efficiency throughout its service life.

The burger formers may be updated; this eventuality shall not prejudice the instructions and explanations contained in the manual.

Before starting up the burger former, you must read this manual carefully.

Should this manual be damaged or lost, apply for a copy from the manufacturer immediately.

Many accidents and injuries that occur when using the machine result from insufficient familiarity with its functions and safety devices. Before starting work with the machine, please read the instructions herein carefully and follow them to the letter.

1.1 Introduction

The burger formers have been designed to comply with applicable safety standards. Consequently, all our burger formers are fitted with a plate featuring the "CE" mark attesting to the product's conformity with said provisions.

1.2 Intended use

This burger former is designed for forming burger patties. The minced meat / vegetables / fish is pressed through a squeegee into a rotating moulding drum. After that, the burger patty can be automatically covered with a release paper. Subsequently, the patty is pressed out of the mold onto the conveyor belt. The conveyor belt conveys the burger patty away from the drum.

The machine features a patty mold with a diameter of 130 mm. You can adjust the patty thickness infinitely (only when the machine is at a standstill) up to a thickness of 32 mm. The machine capacity is up to 1300 patties per hour (theoretically).

Use the burger former exclusively as it was designed to be used.



The burger former must not be used to process frozen food.

Failure to observe the safety instructions may result in severe damage to the machine and cause the warranty to become void.

The machine may only be used in its original condition and with original parts. It is strictly forbidden to dismantle the safety devices. Should any safety devices be damaged, immediately shut down the machine and contact ADE for repair or replacement.

1.3 Residual risks

Even though extensive safety precautions have been taken on the machine, there are still residual risks for the operator in his daily work with the machine. These are particularly associated with the machine's rotating parts. The machine features the following warning signs to alert the operator to the residual risks:

Symbol	Meaning
	Warning of cutting injury
	Warning of hand injuries

2. MACHINE OVERVIEW



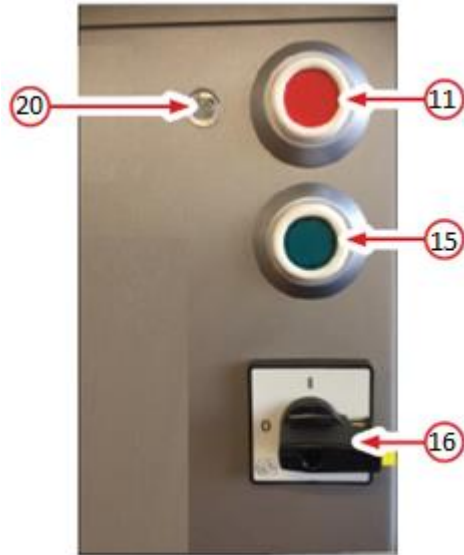

No.	Designation
1	Lid
2	Hopper
3	Drum cover
4	Paper dispenser
5	Drum ring
6	Forming drum
7	Scraper
8	Driven idler pulley
9	Free-running idler pulley
10	Conveyor belt

No.	Designation
11	Stop button
12	Machine housing
13	
14	Lid holder
15	Start button
16	Main switch
17	Lid magnetic sensor
18	Drum cover magnetic sensor
19	Drum housing magnetic sensor
20	Operating voltage indicator

3. INSTALLATION AND START-UP

3.1 Scope of Supply

The burger former is shipped partially assembled. The package includes:

Operating Instructions	Release paper (D)
Burger former	Scraper (E)
Squeegee (A)	Hopper (F) - (factory-assembled)
Conveyor belt (B)	Forming drum (G) - (factory-assembled)
Conveyor belt sliding plate (C)	Lid (H) - (factory-assembled)

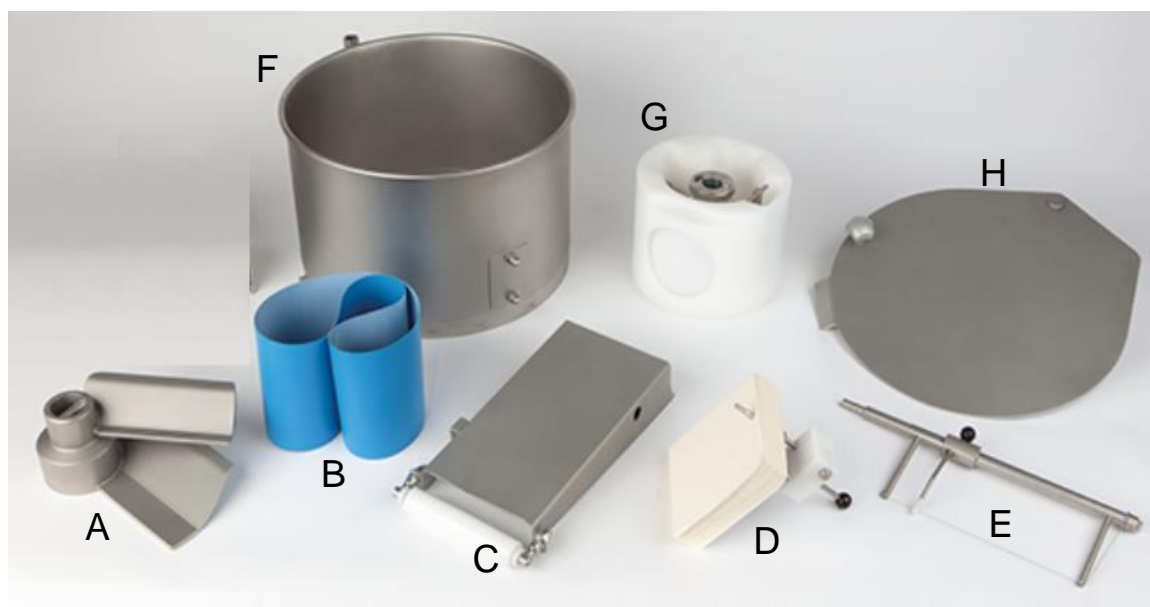

3.2 Unpacking

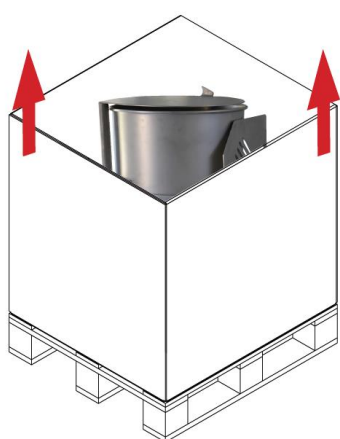

- Upon receiving the machine, inspect the package box and ensure the machine has been delivered in perfect condition.
 - First, remove the screws from the upper part of the box and remove the lid.
 - Then remove the screws from the lower part of the box and lift off the box walls.
 - Check the package contents and ensure they correspond to the specifications on the packing slip.
 - You must also ensure the machine is intact and has not been damaged during transportation.
- Any damages to the burger former must be reported to the transport company in writing within three days of the date of the accompanying documents, specifying in detail the damages found.



The packaging materials are recyclable and must never be disposed of in household waste. Check with the local authorities for the appropriate ways to dispose of waste properly.

The machine must be disposed of under local regulations.

3.3 Setting up the machine

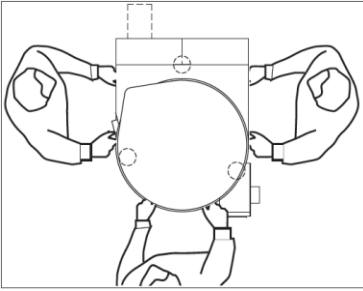

You can now lift the machine off the pallet.

- Pick the machine up at the bottom of the machine housing, as illustrated, preferably with three assistants to ensure maximum safety.
- Place the burger former on a flat, smooth, and vibration-free surface that is stable and sturdy enough to ensure adequate safety, considering the weight of the machine. It is recommended that the table height be about 70 cm and may vary depending on the operator's height. Any unevenness of the surface on which the machine is rested can be compensated using the adjustable feet.
- The machine controls (on/off switch) must face the operator. A minimum space of 4 sq.m should be provided to ensure convenient and smooth operation, cleaning, and maintenance of the machine.
- The machine must be placed in a dry, well-ventilated room away from heat sources.



**Never use the scraper arm to move the machine!
Always remove the scraper arm before moving the machine!**

3.4 Installing the conveyor belt



- Place the conveyor belt around the sliding plate yet to be mounted.
- Fit the sliding plate onto the machine's guide pin and slide the conveyor belt over the drive pulley assembled on the machine side.
- Align the conveyor belt.
- Tighten the conveyor belt by pushing it downwards with the sliding rail.

3.5 Installing the scraper

Loosen the star knob screw.



Fit the scraper into the holder.

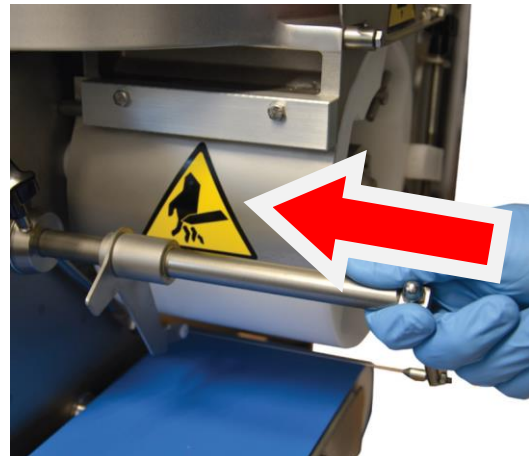

Retighten the star knob screw.

3.6 Fitting the squeegee

Open the lid (1). Attach the squeegee to the drive shaft and turn it clockwise until it engages in the drive shaft.



NOTICE: You can only fit the squeegee in one position.

3.7 Connecting to the power supply

The burger former has a Schuko plug. Before plugging the burger former into the outlet, ensure the power grid features an electrical overload cutout.



Before plugging the machine into the power supply, ensure that the local power supply and current frequency match the specifications on the machine's nameplate.

If this is not the case, never connect the machine to the power supply, as this may cause damage to the machine and lead to fire!

When connecting the machine to the power supply, make sure the connection cable is laid in a way that prevents any risk of tripping or falling.

3.8 Electrical safety devices

The burger former features the following safety devices:

- A magnetic sensor on the lid axis to check whether the lid is closed (17).
- A magnetic sensor to check whether the protective flap is closed (18).
- A sensor to check whether the drum has been installed (19).
- The burger former stops automatically in the event of a power failure. Restart the machine once the power supply is restored.



All safety devices are permanently fitted to the machine and must not be removed. Dismantling them or any unauthorized modifications would make the machine unsafe.

The machine must only be used for its intended purpose. Improper or unintended use of the machine may pose a risk to the health and safety of persons and result in property damage.

The manufacturer shall not be held liable for any damage caused by improper use of the machine, failure to comply with the safety information in this manual, and tampering with or modifications to the machine without official approval from the manufacturer.

3.9 Safety precautions

- The burger former must only be operated by trained and skilled personnel.
- Children, disabled persons, and untrained personnel must not be allowed to operate the machine.
- Never operate the machine while under the influence of alcohol or drugs.
- Wear tight-fitting clothing to avoid getting caught on the machine's moving parts. Long hair must be tied back or worn under a hair net.
- Avoid wearing rings, bracelets, or chains.
- Never leave the machine unattended while it is running.
- Before carrying out any maintenance work, unplug the machine from the power outlet.
- Never clean the machine under running water or in a water basin.
- Should you notice any unusual noises or unpleasant odors coming from the machine, shut it down immediately, disconnect it from the power supply, and contact customer service.
- Never use the machine with a damaged plug or cord. If you find any defects, shut down the machine immediately and have it repaired by the manufacturer or an authorized service center.
- The power cord may only be replaced by authorized and trained personnel.

3.10 Acceptance testing

Ensure that the hopper, lid, conveyor belt, and forming drum are mounted and in place before running the acceptance test.

- Make sure all the burger former components are correctly assembled.
- Close the lid (1) and the drum cover (3).
- Plug the machine into a power outlet.
- Set the main switch (16) to "I."
- The control lamp (20) should light up.
- Press the green start button (15) and red stop button (11) and check that the machine can be switched on and off.
- Check the direction of rotation of the conveyor belt (10) (direction of arrow).
- Check whether the machine shuts off when the lid (1) is opened.
- Check whether the machine shuts off when the drum cover (3) is opened.



If you find any malfunctions, immediately shut down the machine, tag it clearly as "DEFECTIVE," and contact customer service!

The machine cannot be switched on without the forming drum in place. However, this function has nothing to do with safety and merely prevents unwanted soiling of the machine.

4. USING THE BURGER FORMER

4.1 Operating functions

The burger former has a main switch (16) and is operated using two buttons. The green start button (15) switches the machine on, and the red stop button (11) switches it off. The control lamp (22) indicates that the mains voltage is applied.

4.2 Switching on

Power up the machine using the main switch (16). Start up the machine by pressing the green start button (15).

4.3 Securing the machine against accidental switch-on

Before carrying out maintenance work and fitting/replacing the burger mold, the machine must be secured against accidental switch-on. With the main switch (16) in the "0" position, press its yellow lock down and secure it with a small padlock.

4.4 Switching off

Switch off the machine by pressing the red stop button (11). Be sure to shut down the machine with the main switch (16) when not in use and when you leave it unattended.

4.5 Feeding in food and cutting

Open the lid (1) and put minced food into the hopper (2). Close the lid. Power up the machine with the main switch (16).

Press the green start button (15). The product will fall onto the conveyor belt to be carried away from the drum. Promptly pick up the finished product from the conveyor belt by hand.

Clean the scraper wire of product residues during operation, if necessary. In doing so, move the scraper to the right and left once during operation, if necessary.

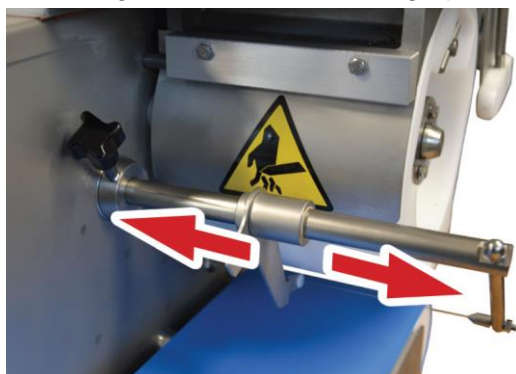

5. INSERTING RELEASE PAPER

1. Remove the paper holder by pressing the button (A) and pulling the paper holder out of the guide.



2. Tighten the compression spring. Put the paper pad on the holding rod and remove the banderols and the cardboard wrappers.

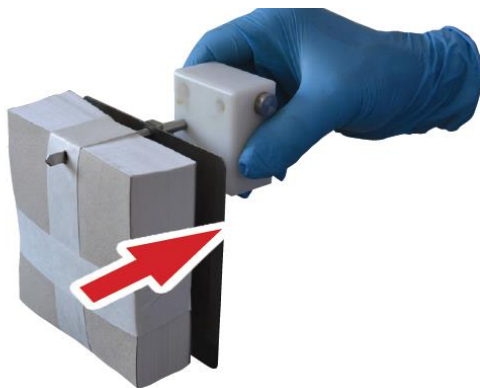

3. Push the paper holder into the guide until it clicks into place. Press the button (B). The spring pushes the paper stack forward.

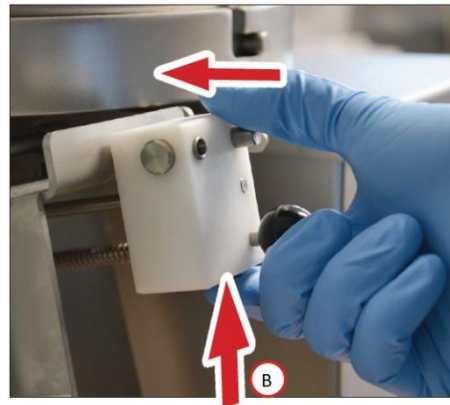

4. Release the paper holder lock by pulling the lever (C) upwards and pushing the entire paper feeder against the drum.



5. Start up the machine. If the paper is not positioned correctly under the product, use the star knob screw (D) to align the paper correctly under the product.



6. ADJUSTING PRODUCT THICKNESS AND WEIGHT

The machine comes factory preset. Before changing the product thickness and weight, shut off the machine with the main switch (16).

Fold up the drum cover.



Turn the drum ring clockwise and pull the drum off the drive shaft.



Loosen the locking screw (A) that secures the white regulating disk.



Turn the regulating disk (B) to change the product thickness.

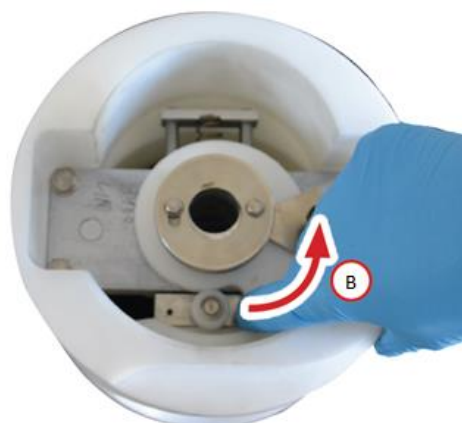

As you turn the regulating disk, the spring in the forming drum is tensioned. Use caution when turning the spigot of the regulating disk, as overdoing will slacken the spring and may pinch your finger!

Retighten the locking screw (A).

Replace the drum.



The drum is mounted correctly when the drum ring engages in the slot at the end of the drive shaft.



7. CLEANING AND CARE

For the sake of hygiene, the burger former must be kept clean at all times. The machine must be disassembled and cleaned thoroughly at the end of each working day and whenever the type of food or type of meat (e.g., change from pork to beef or poultry) being processed is changed.

Make sure to clean all parts and cavities that come into contact with food and in which product residues can build up.

Cleaning of the burger former must only be carried out by trained personnel.



Before cleaning, unplug the machine from the power supply!

Never clean the burger former or its parts in the dishwasher!

Exception: The conveyor belt (without the sliding plate!) and the forming drum can be cleaned in the dishwasher.

Under no circumstances use sodium-hypochlorite-based solutions or abrasive detergents as they would irreparably damage the machine's surfaces. Never use solvents, thinners or alcohol, etc. for cleaning.

The cleaning of the burger former with harmful products liable to affect the health of either operators or customers is strictly prohibited. Only use products with a pH value of 7-8 for cleaning.

Clean the structure of the machine with soft cloths, sponges, and rinse with water frequently. Finally dry with soft and dry cloths. If drying is insufficient, there is a risk of flash rust forming.



Under no circumstances must the machine or parts of it be cleaned with a powerful water jet, high-pressure or steam jet cleaner!

It is possible to rinse the machine with running water from the water hose.

Removing the hopper

Open the lid.



Turn the hopper counter-clockwise and lift it off.



Removing the squeegee

Turn the squeegee counter-clockwise and lift it off.



Removing the conveyor belt

Lift the conveyor belt at the front end about 30° to 40°.



Pull the conveyor belt with the sliding plate off the machine.

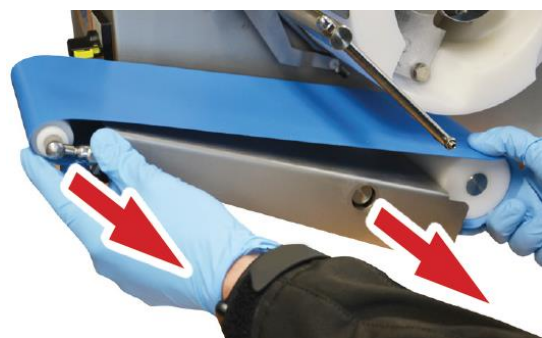

Removing the forming drum

Fold up the drum cover.



Turn the drum ring clockwise and pull the drum off the drive shaft.



Removing the scraper

Loosen the star knob screw.

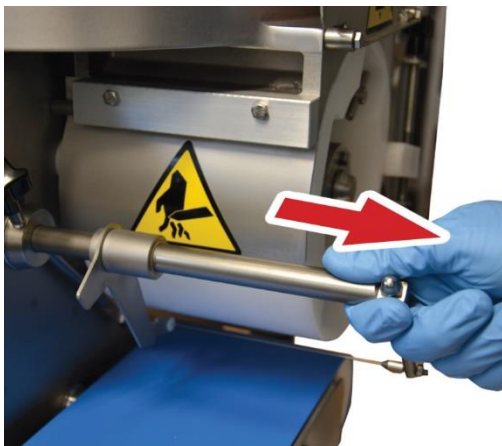

Pull the scraper out of the holder.

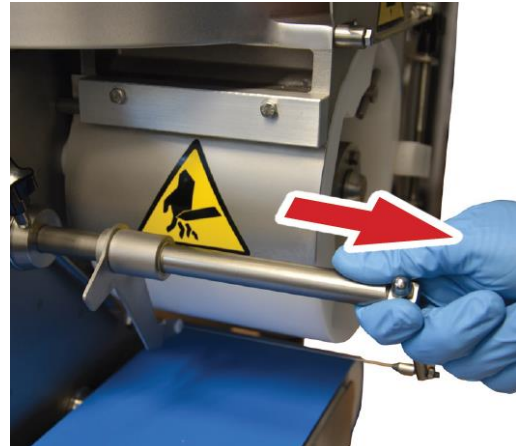

Cleaning the disassembled parts

Only clean the disassembled parts with hot water and a neutral detergent. Then dry the parts well.

Mounting the cleaned parts

Fit the cleaned parts back by following the disassembly procedure in reverse order. In doing so, proceed as follows:

Fitting the hopper

Assemble the hopper so that the magnetic holder is positioned next to the lid axis.

Fitting the squeegee

Ensure the squeegee is fully seated on the drive shaft and locks into the drive shaft when twisted.

NOTICE: You can only fit the squeegee in one position.

Fitting the drum

The drum is assembled correctly when the drum ring engages in the slot at the end of the drive shaft.



8. TRAINING

During the machine's installation, an operator of age must be trained in the regular use-cleaning-care, especially regarding the hazards which are likely to be encountered if the machine is operated incorrectly.

The training will be given by the suitably authorized and trained installer familiar with the European community machine standards.

9. DISPOSAL



Waste electrical and electronic equipment must not be disposed of in household waste. Equipment with this marking must not be disposed of in residual waste and must be recycled.

10. WARRANTY

If the product malfunctions within 1 year from the date of purchase (receipt required) due to defects in material and workmanship, ADE will repair or replace the product.

The warranty does not cover moving parts such as the scraper, conveyor belt, squeegee, drum, etc. The warranty does not extend to external normal wear and tear or damage caused by accident or misuse.

This warranty does not cover the products tampered with by unauthorized personnel.

The warranty agreement does not affect the customer's statutory rights.

Any complaints shall be submitted to the dealer from whom you purchased the machine.

11. TECHNICAL DATA

Model	Bully1000-230
Round patty diameter	130 mm
Patty thickness (max.)	max. 32 mm
Hopper volume	16 l
Conveyor belt length:	450 mm
Machine dimensions	
Width:	518 mm
Depth:	579 mm
Height:	607 mm
Power	0.55 kW
Net weight	57 kg
Current type	230 V, 50 Hz
IP-Protection (Machine)	IP65
IP- Protection (Switch)	IP69

12. DECLARATION OF CONFORMITY

ADE



EC declaration of conformity

Manufacturer: ADE Germany GmbH
Neuer Höltigbaum 15
22143 Hamburg / Germany

Person authorized to compile
the technical documentation: ADE Germany GmbH
Neuer Höltigbaum 15
22143 Hamburg / Germany

Type/Model: Burger forming machine
Bully1000

Serial numbers:
Bully1000-230 62229-xxxxxxx-00001 until 62229-xxxxxxx-99999

The above manufacturer declares under sole responsibility that the above machine complies with the requirements of the following EC directives in the currently valid version:

2006/42/EC	Machinery Directive	(OJ L 157, June 9, 2006, p. 24 – 86)
2014/30/EU	EMC directive	(OJ L 96, March 29, 2014, p. 79 – 106)
2011/65/EU	RoHS directive	(OJ L 174, July 1, 2011, p. 88 – 110)

Directive 2014/35/EU is complied with in terms of its protection objectives in accordance with Annex I No. 1.5.1 MRL 2006/42/EC.

This declaration only applies to the machine in the condition in which it was placed on the market. The declaration becomes invalid as soon as a change is made to the machine that has not been agreed with the manufacturer.

P. Mack

Managing Director

Hamburg, April 5th, 2023

Location, Date

13. DIAGRAMS

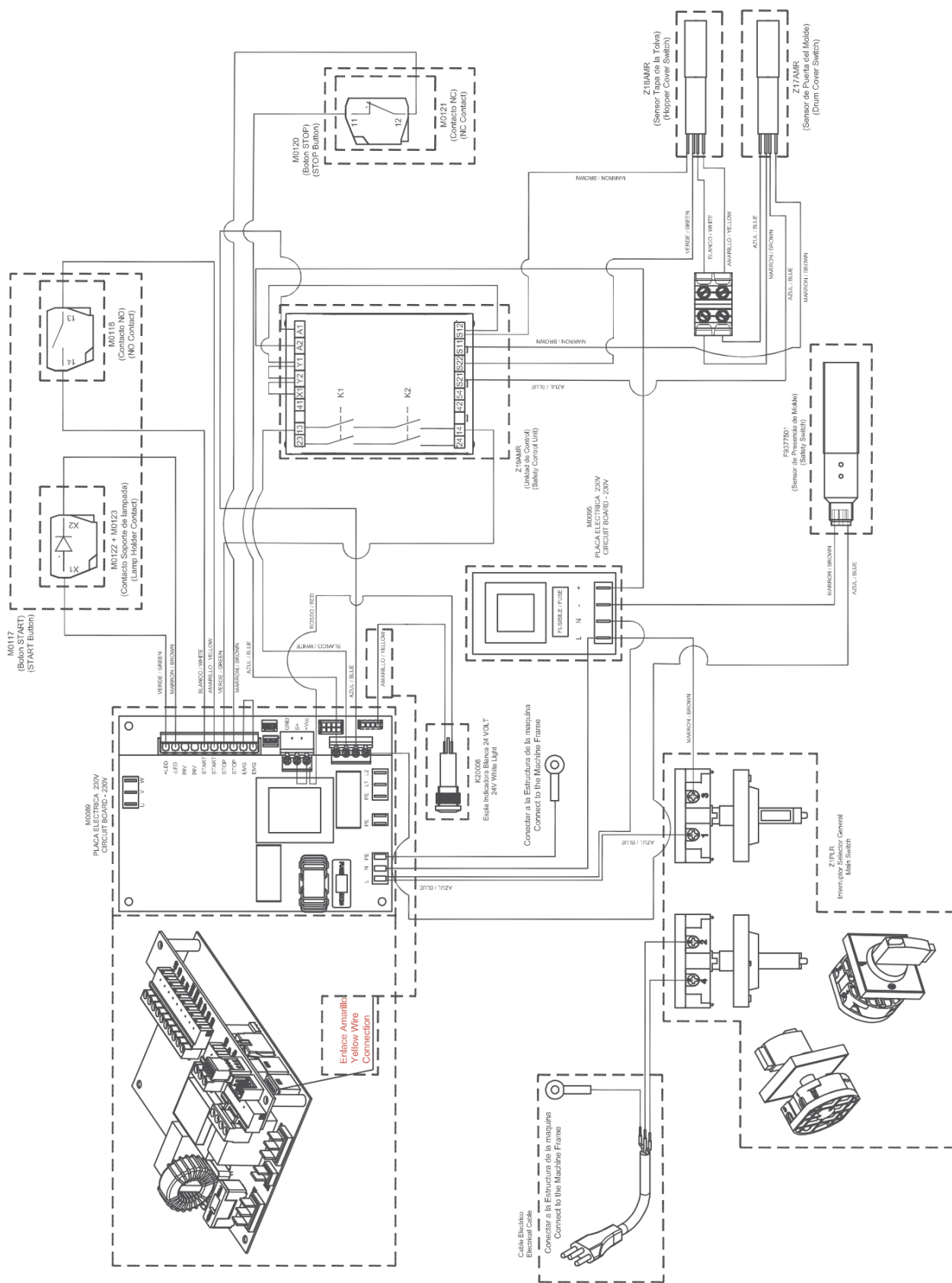

14. SPARE PARTS/ACCESSORIES

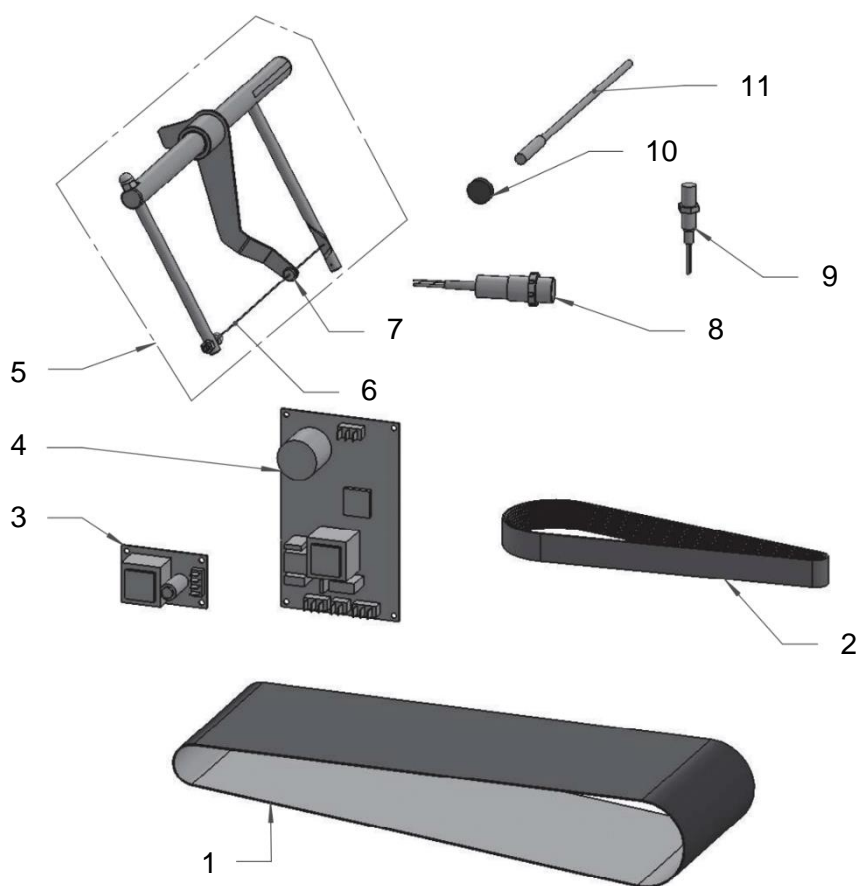

No.	Designation	Item No.
1	Conveyor belt (standard - 140 x 840 mm)	H4352-xxx
2	Drive belt	H4352-xxx
3	Voltage converter 230 V/24 V	H4352-xxx
4	Inverter board 230 V 50/60 Hz	H4352-xxx
5	Scraper assembly	H4352-xxx
6	Stainless steel wire Ø 0.8 mm	H4352-xxx
7	Cleaning disk	H4352-xxx
8	Capacitive sensor Ø 18 mm	H4352-xxx
9	Sensor Ø 8 mm	H4352-xxx
10	Magnet 18 x 14.5 mm	H4352-xxx
11	Sensor Ø 10 x 0.75 2NA	H4352-xxx
12	White non-stick parting film	Z4352-001
13	Stainless steel scoop	Z4352-002

Distributor:

--

Manufacturer:

ADE Germany GmbH

Neuer Höltigbaum 15

22143 Hamburg

 +49 40 432 776 - 0

 +49 40 432 776 - 10

 info@ade-germany.de

 www.ade-germany.de